

Portable Automatic Gas Cutter



BGA00A01

PICLE1-II

Pipe Cutter

OPERATION MANUAL



For every person who will be engaged in operation and maintenance supervision, It is recommended to read through this manual before any operations, so as to permit optimum operation of this machine.

KOIKE SANSO KOGYO CO.,LTD.

INTRODUCTION

Thank you very much for purchasing this product. Read this instruction manual thoroughly to ensure correct, safe and effective use of the machine. Read the manual first to understand how to operate and maintain the machine.

Make sure you read, understand and take all the necessary safety precautions.









SAFETY PRECAUTIONS

This product is designed to be safe, but it can cause serious accidents if not operated correctly. Those who operate and repair this machine must read this manual thoroughly before operating, inspecting and maintaining the machine. Keep the manual near the machine so that anyone who operates the machine can refer to it if necessary.

- Do not use the machine carelessly without following the instructions in the manual.
- Use the machine only after you completely understood the contents of the manual.
- If an explanation in the manual is difficult to understand, contact our company or sales service office.
- Keep the manual near by at all times and read it as many times as necessary for a complete understanding.
- If the manual becomes lost or damaged, place an order with our company or sales service office for a new one.
- When transferring the machine to a new owner, be sure to hand over this instruction manual as well.

QUALIFICATIONS FOR MACHINE OPERATOR

Operators and repair staff of this machine must completely understand the contents of the instruction manual and they must be qualified and educated to handle this equipment.

Symbol	Title	Meaning
	General	General caution, warning, and danger.
	Be careful not to get your fingers caught.	Possible injury to fingers if caught in the insertion part.
	Caution: Electric shock!	Possible electric shock under special conditions.
	Ground this equipment.	Operators must ground the equipment using the safety grounding terminal.
	Pull out the power plug from the outlet.	Operators must unplug the power plug from the outlet when a failure occurs or when there is a danger of lightning.
	Caution against bursting	Possible bursting under certain conditions.
	General	General warning.
	Caution: Hot!	Possible injury due to high temperature under certain conditions.
	Caution: Ignition!	Possible ignition under certain conditions.

CONTENTS

1. Safety Information	3
■ WARNING	3
■ CAUTION	3
■ NOTICE SIGNS	3
1.1 General machine safety precautions	3
1.1.1 Machine safety	3
1.1.2 Safety clothing	3
1.1.3 Operations and handling safety precautions	3
1.1.4 Maintenance and inspection precautions	4
1.2 Gas cutting safety precautions	4
1.2.1 Prevention of explosion	4
1.2.2 Pressure regulator safety precautions	4
1.2.3 High pressure gas cylinder safety precautions	4
1.2.4 Safety precautions for hoses	5
1.2.5 Safety precautions for fire	5
1.2.6 Safety precautions for skin burns	5
2. Locations of safety labels	6
3. Outline of machine	6
3.1 Features of machine	6
3.2 Name and function of each section	6
3.3 Specifications	7
3.4 Accessories	7
4. Preparation for operation	7
4.1 Contents of package	7
4.2 Machine assembly	8
4.3 Preparation for operation	8
4.3.1 Gas supply hose connection	8
4.3.2 Connecting the tip	8
4.3.3 Determination of number of chains	8
4.4 Securing machine to pipe	8
5. Cutting operation	9
5.1 Safety measures prior to operation	9
5.1.1 Selection of tip	9
5.2 Ignition and flame adjustment	9
5.3 Cutting and piercing method	10
5.4 Procedures for starting cutting operation and extinguishing the flame	10
5.5 Safety measures against backfire and flashback	10
5.5.1 Prevention of backfire	10
5.5.2 Prevention of flashback	11
5.6 Cutting operation	11
6. Maintenance and inspection	12
6.1 Daily inspection	12
7. Trouble shooting	12
8. Sketch drawing of PICLE 1-II	12
9. Parts list	13
Main and driving units	14

10. Cutting Data	16
102 (STANDARD SPEED) for Acetylene	16
102-D7 (HIGH SPEED) for Acetylene	16
106 (STANDARD SPEED) for Propane	17
106-D7 (HIGH SPEED) for Propane	17

1 Safety information

Operation, inspection, and maintenance that disregard the basic safety rules cause many accidents. Carefully read, understand, and master the safety measures and precautions described in this instruction manual and on the machine before operating, inspecting, and maintaining the machine. The safety messages are classified as indicated on the machine safety labels:

■WARNING



This word is used in a warning message and a warning label is positioned at places that could cause injury or serious accident.

■CAUTION



This word is used in a caution message and a caution label is positioned at places that could cause slight injury or machine damage. This is also used as a caution for frequent dangerous actions.

■NOTICE SIGNS



This is a sign to show machine operators and maintenance engineers items that relate directly to damage of machines and surrounding facilities and equipment.

1.1 General machine safety precautions

Read and fully understand the following important safety information:

1.1.1 Machine safety

- 1.The machine casing is mainly made of aluminum alloy to reduce weight. For this reason, be careful not to drop a heavy item on the machine, or not drop the machine when carrying it, since the alloy is not designed to withstand such impact.
- 2.When mounting hoses to the torch and distributor, tighten the nut with the attached wrench. After mounting, be sure to check there is no gas leak with a detection liquid. If a gas leak is found, retighten the nut firmly.
- 3.When fixing a tip to the torch, tighten the nut with the two wrenches attached. In addition, avoid damaging the taper part of the tip since this may cause backfire.
- 4.Never disassemble the machine other than during maintenance and inspection. Otherwise, malfunction will result.
- 5.Never remodel the machine. Remodeling is very dangerous.

1.1.2 Safety clothing

- 1.Be sure to wear protectors (gauntlets, goggles, helmet, and safety shoes) during operation.

1.1.3 Operation and handling safety precautions

1. Read this instruction manual before operating the machine.
2. Mount and center the machine correctly and confirm correct motion before operation.
3. Prior to operating the machine, check the safety of the surroundings to avoid accidents.
4. Never move the machine while the preheat flame is on.
5. Take great care of spatters and drops when operating the machine at a high position. They may

injure people below.

6. Do not hit any object against the surface of the wheel to be in touch with pipes or drop the wheel so as not to scratch the surface; otherwise knocking will result.
- 7. Week chain tension will make the machine slip. Give an appropriate tension to the chain.**
8. Be careful not to get your hand caught between the upper plate and slide bracket.
9. When stretching the chain, be careful not to get your hand caught in the wing bolt.
10. Do not insert your hand into rotary sections (sprocket and wheel).
11. Be careful not to drop the machine when changing the chain.
12. Do not use deformed or rusted chains; otherwise the chain may be disengaged.
13. Do not mistake the top and bottom sides of the chain.
14. The number of chains must match the pipes.
15. Do not place the machine on pipes when it is unused.
16. Be careful not to damage the wheel.
17. The planer deflection due to a worm wheel causes curved cutting surfaces and discrepancy between the first and last cutting positions.

1.1.4 Maintenance and inspection precautions



1. Ask a qualified electrician to perform repair and inspection service.
2. Maintain the machine periodically.

1.2 Gas cutting safety precautions

Strictly observe the safety rules and precautions to ensure the safety of gas cutting operations. Operators and supervisors MUST keep safety in mind.

1.2.1 Prevention of explosion



1. Never cut pressurized cylinders or hermetically sealed containers.
2. Ensure sufficient ventilation for gas cutting to prevent the air from becoming stale.

1.2.2 Pressure regulator safety precautions



1. Before starting operation, check that all pressure regulators are operating correctly.
2. Ask a skilled repair engineer to perform maintenance and inspection service.
3. Do not use pressure regulators from which gas is leaking, nor malfunctioning pressure regulators.
4. Do not use pressure regulators smeared with oil or grease.

1.2.3 High Pressure gas cylinder safety precautions



1. Never use broken cylinders or cylinders from which gas are leaking.
2. Install cylinders upright and take measures to prevent them from falling.
3. Use cylinders only for specified purposes.
4. Do not smear container valves with oil or grease.
5. Install cylinders in a place free from heat, sparks, slag, and open flame.
6. Contact the distributor if the container valves will not open.
Never use a hammer, wrench, or other tools to forcibly open container valves.

1.2.4 Safety precautions for hoses



1. Use the oxygen hose for oxygen gas only.
2. Replace cracked hoses or other hoses damaged by sparks, heat, unshielded fire, etc.
3. Install hoses without twisting.
4. To prevent breakage of hoses, take great care during operation and transportation.
5. Do not hold the hoses when moving the machine.
6. Periodically check the hoses for damage, leakage, fatigue, loose joints, etc, to ensure safety.
7. Cut hoses to the minimum possible length. Short hoses reduce hose damage and pressure drop, as well as reduce the flow resistance.

1.2.5 Safety precautions for fire



Take safety precautions to prevent fire prior to gas cutting.
Ignoring hot metal, sparks, and slag could cause a fire.

1. Keep a fire extinguisher, fire extinguish sand, bucket full of water, etc. ready on the site where gas cutting is performed.
2. Keep flammables away from the cutting area to avoid exposure to sparks.
3. Always cool down steel plates that have become hot after cutting, as well as hot cut parts or scrap, before bringing them close to flammables.
4. Never cut containers to which flammable materials are stuck.

1.2.6 Safety precautions for skin burns



Observe the safety precautions to prevent skin burns. Ignoring heat, spatter, and sparks during operation could cause a fire or burned skin.

1. Do not perform cutting near flammables. (Move flammables well away from the sparks.)
2. Do not cut containers filled with flammables.
3. Do not keep lighters, matches, and other flammables nearby.
4. Flames from the torch will burn the skin. Keep your body away from the torch and tip, and check the safety before operating the switches and valves.
5. Wear the correct protectors to protect your eyes and body.
6. Correctly tighten the tip to prevent backfire.
 - When fixing a tip to the torch, tighten the nut with the two wrenches attached.
 - If the tip is tightened excessively, it will be heated during cutting and tightened still more, making it difficult to remove the tip.
 - Avoid damaging the taper of the tip since this may cause backfire.
7. Check with soapsuds for any leakage of gas from the connection part of the distributor, hose and torch. Never use oil or grease on the connection of the oxygen pipe to avoid backfire which may lead to explosion.
8. Be sure to check the following when igniting:
 - Place the torch on the torch holder before igniting.
 - Always wear the required protectors (gauntlets, helmet, goggles, etc.)
 - Check for any obstacles, dangerous materials and flammables near or in the direction of cutting. Determine the gas pressure.
 - The gas pressure must be within the appropriate range. (For the gas pressure, refer to the Cutting Data.)
9. The torch, tip and heat shield are heated to a very high temperature. Always wear gauntlets when handling them. Also the surface after cutting is very hot so do not touch it even while wearing gauntlets.
10. Never move the machine while the preheat flame is on.

2 Location of safety labels

Safety labels and other labels for correct operation are affixed to the machine.
 Carefully read the labels and follow the instructions on them when operating the machine.
 Never remove the labels. Keep them clean and legible at all times.

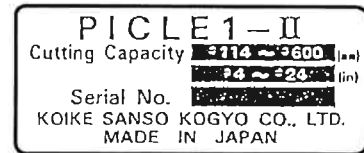
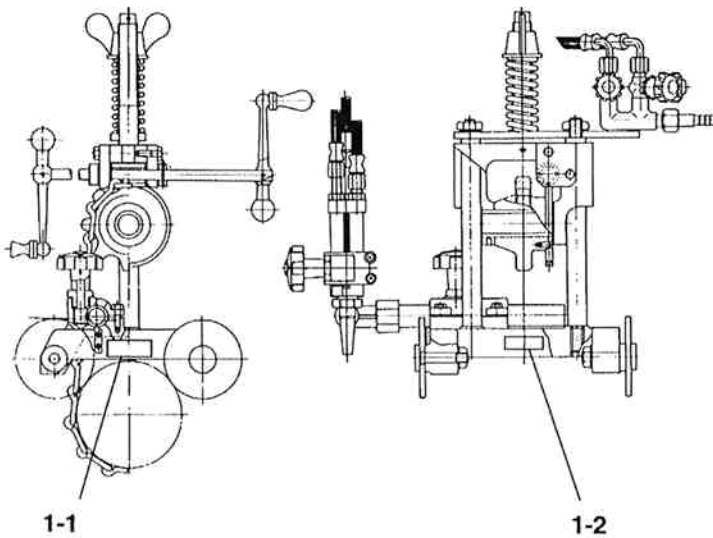

1-1

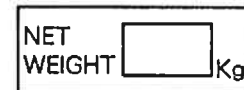

1-2

3 Out line of machine

3.1 Features of machine

PICLE1-II (PIPE CUTTER) is a compact pipe cutter developed on the basis of the actual conditions of installed pipelines and work site where pipe cutting is needed. The machine will exhibit excellent performance in straight and bevel cutting of all sizes of pipes, which accounts for most of pipe cutting work, being habitually used by many users.

3.2 Name and function of each section

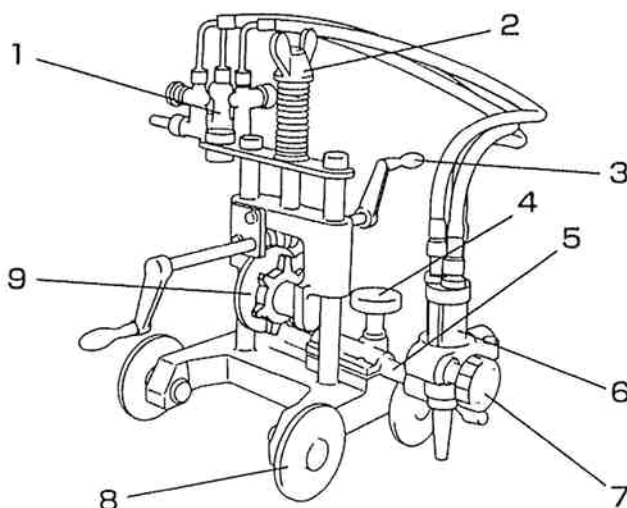

- | | |
|--|---|
| <ol style="list-style-type: none"> 1. Gas distributor
Controls the flow of preheating oxygen, fuel gas and cutting oxygen, forming a cutting flame. 2. Wing nut
Controls the chain tension. 3. Handle
Drives the machine. 4. Torch slide handle
Moves the torch right or left. | <ol style="list-style-type: none"> 5. Lateral bar 6. Torch 7. Up/down handle
Moves the torch up and down. 8. Wheel 9. Sprocket
Engaged with the chain, the sprocket rotates to move the machine. |
|--|---|

3.3 Specifications

Weight:	8.5kg
Length:	410mm
Wheel width:	210mm
Height:	410mm
Effective pipe cutting diameter:	114-600mm
Thickness of pipe to be cut:	50mm
Cutting shape:	I-shape cutting and V-bevel cutting (up to 45 degree)
Drive system:	Manual
Range of vertical torch movement:	50mm
Range of lateral torch movement:	100mm

3.4 Accessories

Tip 102 (for acetylene) or 106 (for propane):	#0.1.2 one each
Tip cleaning needle:	1set
Lighter:	1set
Chain (80pcs):	1set

4 Preparation for operation

4.1 Contents of package

The contents of the standard package are shown below. Check them carefully before assembling the machine.

● Body	1 set
● Gas distributor	1 set
● Torch holder	1 set
● Torch	1 set
● Hose	
Distribution hose (3 pcs set: 560L biased bend)	1 set
● Tip 102 (for acetylene) or 106 (for propane) #0.1.2	one each
● Tip cleaning needle	1 set
● Lighter	1 set
● Chain (80 pcs)	1 set

4.2 Machine assembly

1. Carefully take the machine out of its case.
2. Carefully check that the torch holder, gas distributor, torch and etc. are in position.
3. Attach the primary hoses to the gas distributor.
 - Oxygen hose
 - Gas hose

4.3 Preparation for operation



4.3.1 Gas supply hose connection

1. Connect the respective gas supply hoses to the torch and distributor.
2. Check that hoses are connected correctly and there is no gas leakage.
3. Carefully check the cutting oxygen (JO), preheating oxygen (PO), preheating gas and respective marking before connecting hoses to the torch and distributor.

4.3.2 connecting the tip

1. select a proper tip according to the thickness of the steel plate and attach it to the torch.

(To select a tip, refer to the table of cutting data.)

 - When fixing a tip to the torch, tighten the nut with the two wrenches attached.
 - If the tip is tightened excessively, it will be heated during cutting and tightened still more, making it difficult to remove the tip.
 - In addition, avoid damaging the taper of the tip since this may cause backfire.

4.3.3 Determination of number of chains

The relationship between the pipe O.D. and the number of chains is as follows.

$$Y = X + 11$$

where, Y = the number of chains

X = pipe O.D. (unit:cm; Round off the value in mm to the next value in cm.)

For example, pipe O.D. 114.3mm 11.43cm 12

$$\begin{aligned} Y &= X + 11 \\ &= 12 + 11 \\ &= 23 \end{aligned}$$

Therefore, about 23 chains are necessary.

4.4 Securing machine to pipe

1. Calculate the necessary number of chains, place the main unit on the pipe to be cut and turn the tightening handle counterclockwise to lower the side bracket.
2. Engage the chain with the sprocket and attach the chain as shown in the figure to set it on the pipe.

(Do not confuse the right side of the chain with its wrong side. Rounded side faces to the pipe.)
3. Turn the tightening handle clockwise and fix the main unit to the pipe. When turning the tightening handle, exercise care so that the spring will not be in close contact, leaving a clearance of 1-2mm.
4. To avoid a chain engagement error or chain loosening, hold the machine by hand and turn the handle to the right and left within the range of approx. 120 degrees two or three times, tensioning the chain gradually.
5. After setting, turn the handle by one turn and check to see if the hose length is sufficient and the

cutting tip returns to the original position.

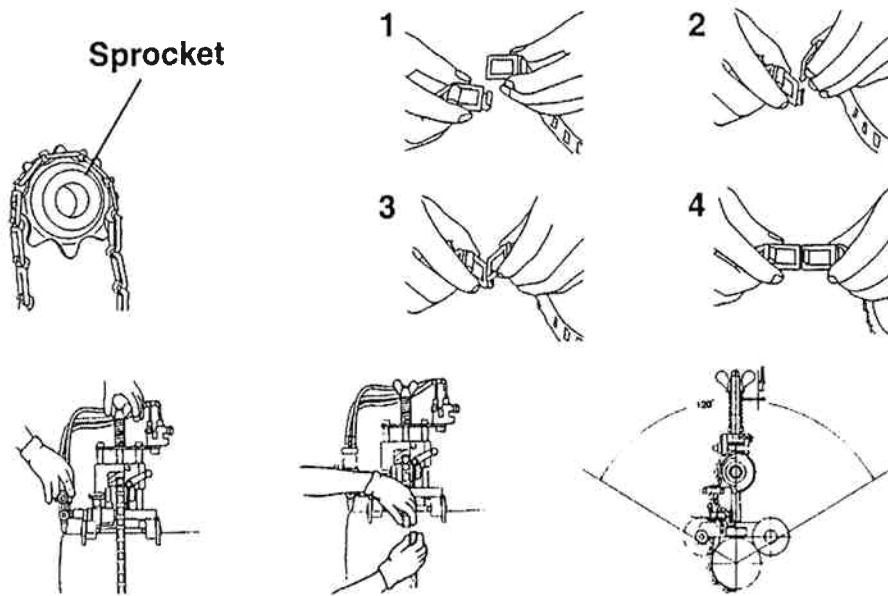

5 Cutting operation



5.1 Safety measures prior to operation

5.1.1 Selection of tip

Referring to the Cutting Data, select the suitable tip according to the plate thickness.

For a heavily rusted plate or for a bevel cutting angle of more than 20 degree, select the tip one grade higher than the one shown in the Cutting Data.

5.2 Ignition and flame adjustment

Adjust the gas pressure according to the Cutting Data. The data shows the pressure when all the valves are open. Readjust the pressure after ignition. (See page 16.)

Flame adjustment method

1. Open the fuel gas valve 1/4 to 1/2 a turn and light the torch with an igniter.
2. Then, open the preheating oxygen valve gradually until a white cone of the standard flame has been obtained. (The incandescent area should be uniform and about 5-6 mm in length.)
3. Open the jet oxygen valve fully. Readjust the flame if its condition has changed. A disorderly flow of the jet oxygen will adversely affect the quality of the cutting surface. In such a case, clean the tip with a suitable cleaning needle while the jet oxygen is flowing.
4. Appropriate distance between the tip end and cutting surface:

Acetylene gas	8-10 mm
LPG gas	5-8 mm

Neutral flame ensures a good quality cut surface. (Oxidized flames may be used for bevel cutting.)

The oxidized flame shortens the cutting oxygen flow, causing slug deposition or melting the upper edge of the cut surface. Excessively high cutting oxygen pressure will cause the same effect.

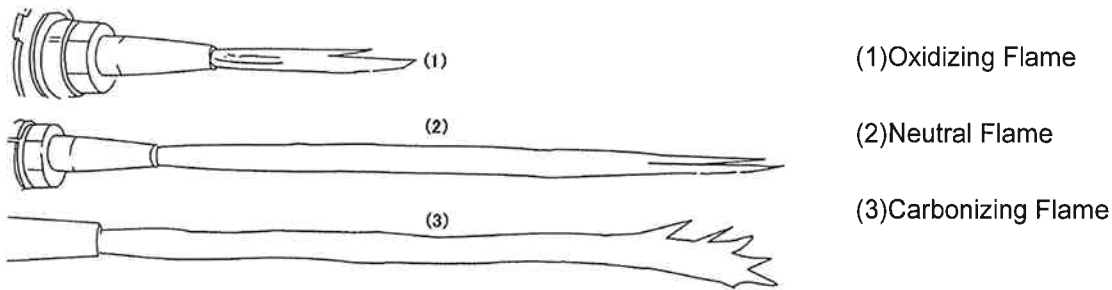

(1)Oxidizing Flame

(2)Neutral Flame

(3)Carbonizing Flame

5.3 Cutting and piercing method

1. Cut in from the end of steel plate.
2. Pierce steel plate before cutting.
3. Drill a hole before cutting.

Piercing method

1. Ignite and adjust the flame.
2. Thoroughly preheat the cut-in point until it is white hot.
3. Open the cutting oxygen valve to pierce the steel plate. The tip should be about 15-20 mm from the plate to prevent slag from splashing onto the tip and adhering there, which will shorten the working life of the tip.

5.4 Procedures for starting cutting operation and extinguishing the flame

1. Align the tip with the cutting start point, ignite and then adjust the flame.
2. Sufficiently preheat the cutting start point.
3. After heating, supply cutting oxygen and turn the handle simultaneously to being cutting.
4. Carefully check the cutting condition and turn the handle to set an optimum cutting speed. Refer to the Cutting Data.
5. Extinguish the flame after cutting as follows:
 - 1) Stop the handle.
 - 2) Close the cutting oxygen valve.
 - 3) Close the preheating oxygen valve.
 - 4) Close the fuel gas valve.

5.5 Safety measures against backfire and flashback



5.5.1 Prevention of backfire



Backfire may cause serious accidents or fires. Be careful to prevent such disaster. When a backfire occurs, find the cause and inspect and maintain the machine correctly before using the machine again.

The following are causes of backfire:

- 1) Improper gas pressure adjustment.
- 2) Overheated tip.
- 3) Slag clogged in tip.
- 4) Damage to the tapered section of the tip or torch will cause backfire.

5.5.2 Prevention of flashback

Flashback could cause fire and break the machine. Should there be a hissing sound in the torch, quickly take the following action.

- 1) Close the preheating oxygen valve.
- 2) Close the fuel gas valve.
- 3) Close the cutting oxygen valve.

Should flashback occur, find the cause and take appropriate action before using the machine again.

5.6 Cutting operation

1. Place the tip at the cutting start point.
2. Ignite the tip and continue preheating sufficiently.
3. Open the cutting oxygen valve and turn the handle simultaneously to begin cutting.
4. While observing the cutting conditions, turn the handle to set the optimum cutting speed.
5. After cutting, stop the handle, and close the cutting oxygen valve, fuel gas valve and preheating oxygen valve in this order.

Thereafter, repeat the operations from the beginning (item 1).

During cutting, hold the wing nut with the right or left hand as shown in the figure.

When the machine moves down, support the machine from the bottom, and when the machine moves up, lift the machine.

